



# ELECTRORED

Bolivia S.R.L.

# SEMIKRON

innovation + service

## DIODO RECTIFICADOR SEMIKRON

TEMPERATURA °C ( -40 ... + 180 )

CODIGO ELECTRORED	TIPO V	VOLTIOS A	CORRIENTE	TAMAÑO	DIMENSIONES EN MILIMETROS				
					a	b	d	i	sw
4258	SKN 26/08	800	25	E8	M6	11	2,7	21,5	11
4261	SKN 50/08	800	50	E10	M6	11	4	25	17
4263	SKN 71/08	800	70	E11	M8	11	4	25,5	17
4265	SKN 130/08	800	130	E14	M12	18	-	165	24
4267	SKN 240/08	800	240	E15	M16x1.5	20	-	190	32
4270	SKN 320/08	800	320	E16	M24x1.5	20	-	230	41
4259	SKR 26/08	800	25	E8	M6	11	2,7	21,5	11
4262	SKR 50/08	800	50	E10	M6	11	4	25	17
4264	SKR 71/08	800	70	E11	M8	11	4	25,5	17
4266	SKR 130/08	800	130	E14	M12	18	-	165	24
4268	SKR 240/08	800	240	E15	M16x1.5	20	-	190	32
4271	SKR 320/08	800	320	E16	M24x1.5	20	-	230	41

### TAMAÑO E 8 / E 10 / E 11

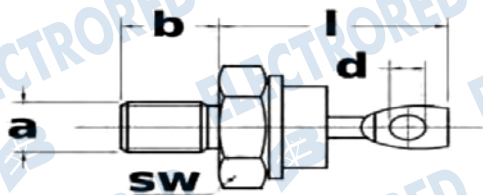

### TAMAÑO E 14 / E 15 / E 16

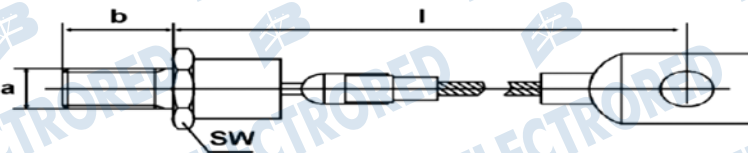

**LA PAZ:**  
Av. I. de las Muñecas N° 494  
entre Pando y Viacha  
Central Piloto: (591-2) 2462046  
electroredlp@electrored.com.bo

**SANTA CRUZ:**  
Av. Sta. Cruz N° 262  
entre Charcas y Puerto Suarez  
Central Piloto: (591-3) 3368888  
electroredsc@electrored.com.bo

**COCHABAMBA:**  
C. Tumusla N° 36  
entre Heroínas y Colombia  
Central Piloto: (591-4) 4583221  
electroredcbba@electrored.com.bo

**EL ALTO:**  
Calle 1 N° 3760 entre Av.6 de Marzo  
y Evadidos del Paraguay  
Central Piloto: (591-2) 2821322  
electroreddea@electrored.com.bo

# DIODO TIRISTOR SEMIKRON

TEMPERATURA °C ( -40 ... + 130 )

CODIGO ELECTRORED	TIPO V	VOLTIOS A	CORRIENTE	TAMAÑO	DIMENSIONES EN MILIMETROS			
					a	b	i	sw
4274	SKT 16/08	800	16	B2	M6	11	30	14
4275	SKT 24/08	800	24	B2	M6	11	30	14
4276	SKT 40/08	800	40	B3	M8	11	33,5	17
4277	SKT 55/08	800	55	B5	M12	18	160	24
4278	SKT 160/08	800	160	B6	M16x1.5	20	190	32
4279	SKT 240/08	800	240	B7	M24x1.5	20	230	41
4280	SKT 250/08	800	250	B7	M24x1.5	20	230	41
4281	SKT 320/08	800	320	B8	-	-	-	-
5523	SKKE 81/12	1200	82	1	-	-	-	-
5826	SKKT 42B16 E	1600	40	1	-	-	-	-

## TAMAÑO B 1 / B 2 / B 3

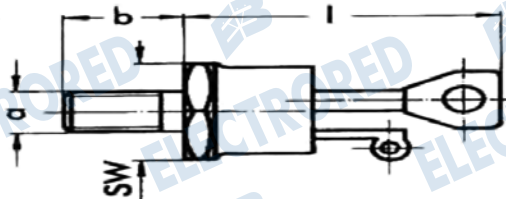

## TAMAÑO B 5 / B 6 / B 7

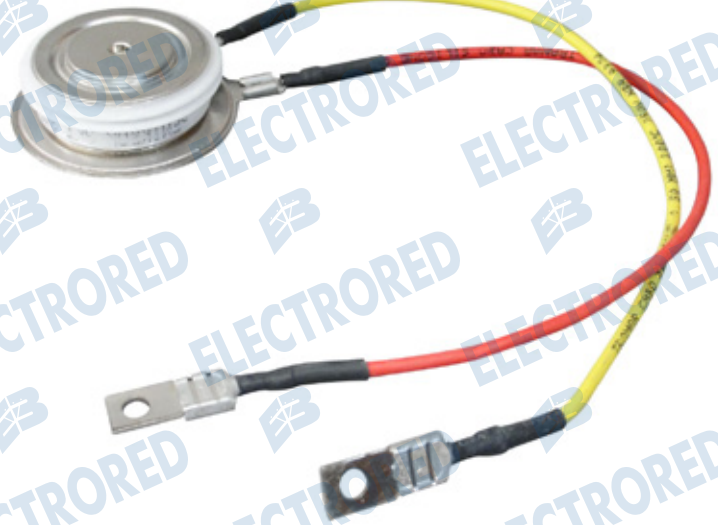
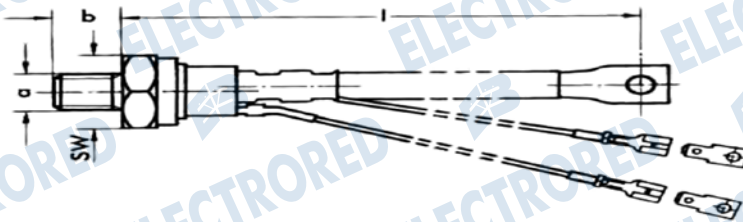

## DIODO PUENTE SEMIKRON

TEMPERATURA °C ( -40 ... + 150 )

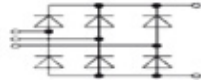
CODIGO ELECTRORED	TIPO V	VOLTIOS A	CORRIENTE	TAMAÑO	CIRCUITO
4284	SKB 25/12	1200	17	G 10b	
4287	SKD 25/12	1200	20	G 11b	

TAMAÑO G 10b / G 11b

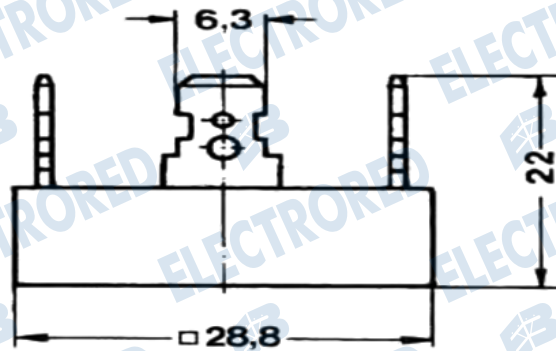

DIMENSIONES EN MILIMETROS



# DIODO PUENTE SEMIKRON

TEMPERATURA °C ( -40 ... + 150 )

CODIGO ELECTRORED	TIPO	VOLTIOS V	CORRIENTE A	TAMAÑO	CIRCUITO
4285	SKB 30/12	1200	30	G12	
4286	SKB 50/12	1200	50	G14	
4288	SKD 30/12	1200	30	G13	
4289	SKD 50/12	1200	50	G15	

TAMAÑO G12 / G13

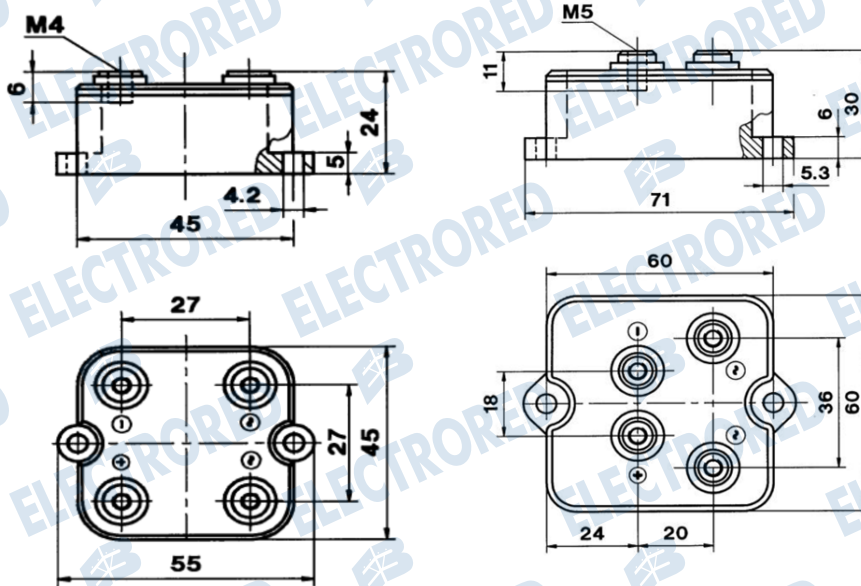

DIMENSIONES EN MILIMETROS

